



# Outdoor Patio Heater

## INFRARED BURNER

Model # LIP-10A-TGG-NTS-1  
Item # 61445



**ATTACH YOUR RECEIPT HERE**

Serial Number \_\_\_\_\_ Purchase Date \_\_\_\_\_

 <b>DANGER</b>
FOR YOUR SAFETY: If you smell gas: 1. Shut off gas to the appliance. 2. Extinguish any open flame. 3. If odor continues, keep away from the appliance and immediately call your gas supplier or fire department.

 <b>DANGER</b>
DANGER indicates an imminently hazardous situation which, if not avoided, will result in death or serious injury.

 <b>DANGER</b>
Failure to comply with the precautions and instructions provided with this heater can result in death, serious bodily injury and property loss or damage from hazards of fire, explosion, burn, asphyxiation, and/or carbon monoxide poisoning. Only persons who can understand and follow the instructions should use or service this heater.

 <b>WARNING</b>
Do not store or use gasoline or other flammable vapors and liquids in the vicinity of this or any other appliance. An LP-cylinder not connected for use shall not be stored in the vicinity of this or any other appliance.

 <b>WARNING</b>
Improper installation, adjustment, alteration, service or maintenance can cause property damage, injury or death. Read the installation, operation and maintenance instructions thoroughly before installing or servicing this equipment.

 <b>WARNING</b>
FOR OUTDOOR USE ONLY!



**Questions, problems, missing parts?** Before returning to your retailer, call our customer service hotline at **1-866-985-7877**, 9 a.m. – 6 p.m., EST, Monday – Friday or email at [cservice@welltraveled.net](mailto:cservice@welltraveled.net).

## TABLE OF CONTENTS

<b>Table of Contents.....</b>	<b>Page 2</b>
<b>Before You Begin.....</b>	<b>Page 2</b>
<b>Safety Information.....</b>	<b>Page 3-4</b>
<b>Package Contents.....</b>	<b>Page 5</b>
<b>Hardware Contents.....</b>	<b>Page 6</b>
<b>Assembly.....</b>	<b>Page 6-11</b>
<b>Operating Instructions.....</b>	<b>Page 11-14</b>
<b>Care and Maintenance.....</b>	<b>Page 14</b>
<b>Troubleshooting.....</b>	<b>Page 15</b>
<b>Replacement Parts List.....</b>	<b>Page 16</b>
<b>Warranty Information.....</b>	<b>Page 17</b>

### BEFORE YOU BEGIN

Please read and understand this entire manual before attempting to assemble, operate or install this appliance. If you have any questions regarding the product, please call customer service **1-866-985-7877**, 9 a.m. – 6 p.m., EST, Monday – Friday.

This manual contains important information about the assembly, operation and maintenance of this patio heater. General safety information is presented in the first few pages and is also located throughout this manual. Keep this manual for future reference and to educate new users of this appliance. This manual should be read in conjunction with the labeling on the appliance. Safety precautions are essential when any mechanical or propane fueled equipment is involved. These precautions are necessary when using, storing, and servicing. Using this appliance with the respect and caution demanded will reduce the possibilities of personal injury or property damage. The following symbols shown below are used extensively throughout this manual. Always heed these precautions, as they are essential when using any mechanical or propane fueled equipment.

 **DANGER**

- \* EXPLOSION – FIRE HAZARD
- \* Keep solid combustibles, such as building materials, paper, or cardboard a safe distance away from the heater as recommended by the instructions.
- \* Provide adequate clearances around air openings into the combustion chamber.
- \* Never use the heater in spaces which do or may contain volatile or airborne combustibles, or products such as gasoline, solvents, paint thinner, dust particles or unknown chemicals.
- \* During operation, this appliance can be a source of ignition. Keep heater area clear and free from combustible materials, gasoline, paint thinner, cleaning solvents and other flammable vapors and liquids. Do not use heater in areas with high dust content. Minimum heater clearances from combustible materials: three (3) feet or 36 inches from top and two (2) feet or 24 inches from sides.

 **DANGER**

- \* CARBON MONOXIDE HAZARD
- \* This heater is a combustion appliance. All combustion appliances produce carbon monoxide (CO) during the combustion process. This product is designed to produce extremely minute, non-hazardous amounts of CO if used and maintained in accordance with all warnings and instructions. Do not block the air flow into or out of the heater.
- \* Carbon Monoxide (CO) poisoning produces flu-like symptoms, watery eyes, headaches, dizziness, fatigue and possibly death. You can't see and you can't smell it. It is an invisible killer. If these symptoms are present during operation of this product get fresh air immediately!
- \* For outdoor use only.
- \* Never use inside house or other unventilated or enclosed areas.
- \* This heater consumes air (oxygen). Do not use in unventilated or enclosed areas to avoid endangering your life.

 **DANGER**

- \* EXPLOSION – FIRE HAZARD
- \* Never store propane near high heat, open flames, pilot lights, direct sunlight, other ignition sources or where temperatures exceed 120 degrees F (49 degrees C).
- \* Propane vapors are heavier than air and can accumulate in low places. If you smell gas, leave the area immediately.
- \* Never install or remove propane cylinder while heater is lighted, near flame, pilot lights, or other ignition sources or while heater is hot to the touch.
- \* This heater is red hot during use and can ignite flammables too close to the burner. Keep flammables at least 3 feet (36 inches) from top and 2 feet (24 inches) from sides. Keep gasoline and other flammable liquids and vapors well away from heater.
- \* Store the propane cylinder outdoors in a well ventilated space out of the reach of children. Never store the propane cylinder in an enclosed area (house, garage, etc.). If heater is to be stored indoors, disconnect the propane cylinder for outdoor storage.

 **WARNING**

WARNING indicates an imminently hazardous situation which, if not avoided, will result in death or serious injury.

 **WARNING:** FOR OUTDOOR USE ONLY



**CARBON MONOXIDE HAZARD**

This appliance can produce carbon monoxide which has no odor. Using it in an enclosed space can kill you. Never use this appliance in an enclosed space such as a camper, tent or home.

## SAFETY INFORMATION

### WARNING

California Proposition 65  
Combustion by-products produced when using this product contain chemicals known to the State of California to cause cancer, birth defects, and other reproductive harm.

### WARNING

#### BURN HAZARD

- \* Never leave heater unattended when hot or in use.
- \* Keep out of reach of children.

### WARNING

Certain materials or items, when stored under the heater, will be subject to radiant heat and could be seriously damaged.

### CAUTION

#### SERVICE SAFETY

- \* Keep all connections and fittings clean. Make sure propane cylinder valve outlet is clean.
- \* During set up, check all connections and fittings for leaks using soapy water. Never use a flame to check for leaks.
- \* Use as a heating appliance only. Never alter in any way to use with any device.

### CAUTION

CAUTION indicates an imminently hazardous situation which, if not avoided, may result in minor or moderate personal injury, or property damage.

### WARNING

\* This product is fueled by propane gas. Propane gas is invisible, odorless, and flammable. An odorant is normally added to help detect leaks and can be described as having a "rotten egg" smell. The odorant can fade over time so leaking gas is not always detectable by smell alone.

\* Propane gas is heavier than air and leaking propane will sink to the lowest level possible. It can ignite by ignition sources including matches, lighters, sparks or open flames of any kind many feet away from the original leak. Use only propane gas set up for vapor withdrawal.

\* Store or use propane gas in compliance with local ordinances and codes or with ANSI/NFPA 58. Turn off propane when not in use.

### WARNING

\* Alert children and adults to the hazards of high surface temperatures. Stay away from these surfaces to avoid burning skin or igniting clothing.

\* Carefully supervise young children when in the vicinity of the heater.

\* Do not hang clothing or any other flammable materials from the heater, or place near the heater.

\* Replace any guard or protective device removed for servicing the appliance prior to placing back in service.

\* Installation and repair should be done by a qualified service person. The heater should be inspected before use and annually by a qualified service person. More frequent cleaning may be required as necessary. It is imperative that the control compartment, burners, and circulating air passageway of the appliance be kept clean.

**PACKAGE CONTENTS**

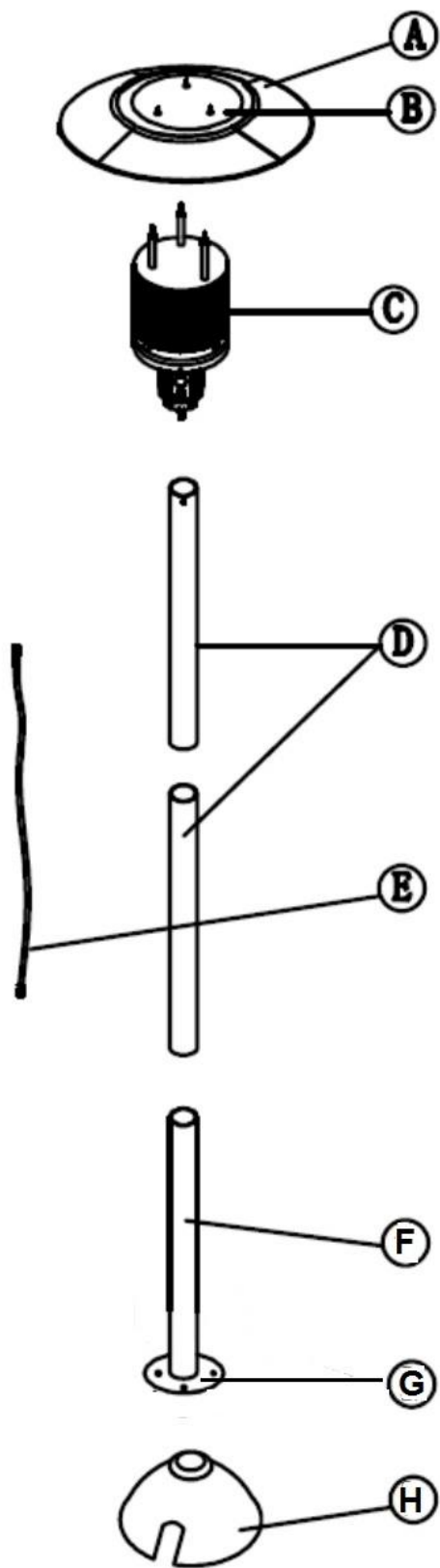

PART	DESCRIPTION	QTY
A	Reflector Panel	4 pcs (packed in 2 inner ctns)
B	Reflector Center Cap	1
C	Head Assembly	1 (packed in 1 inner ctn)
D	Main Post	2
E	Gas Hose	1 (attached to Head Assembly)
F	Lower Post	1
G	Base	1
H	Base Cover	1

## HARDWARE CONTENTS



M6x12 Bolt with  
Lock Washer  
QTY: 10



M8 Wing Nut  
QTY: 3

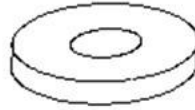

M8 Washer  
QTY: 3

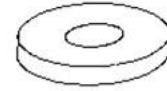

M6 Washer  
QTY: 12

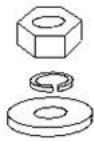

M8 Nut/Lock Washer/Washer  
QTY: 4



M8x110  
Expandable  
Bolt  
QTY: 4

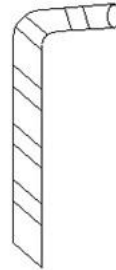

Anchoring Pin  
QTY: 4

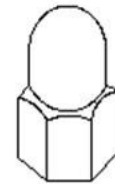

M6 Nut  
QTY: 12

## ASSEMBLY

### PREPARATION

Before beginning assembly of this appliance, make sure all parts are present. Compare all parts with package contents list and hardware contents as listed on pages 5 and 6 of this manual. If any part is missing or damaged, do not attempt to assemble this product. Contact customer service for replacement parts.

**ESTIMATED ASSEMBLY TIME: 60 minutes**

### Tools Required for Assembly (NOT included):

Philips Head Screwdriver with Medium Blade

Drill and/or large Rubber Mallet (used for fixing base to the ground)

Leak Detection Solution

Adjustable wrench (2) (**Note:** 10mm wrench or socket should fit M6 bolt; 13mm wrench or socket should fit M8 bolt.)

# ASSEMBLY

1. To protect your heater from strong winds, it is best to anchor the base securely to the ground. There are two methods you may use to secure the base.

## **OPTION A (for solid ground such as concrete):**

Using the holes in the Base as a template, drill 4 - 12.5-13mm diameter holes (1/2") that are at least 300mm (4") deep. **Fig. 1**

Then insert the Expandable Bolts (4 pcs) into the holes. **Fig. 2**

Slide the Base down over the Expandable Bolts. **Fig. 3**

Affix the Base to the Expandable Bolts using the M6 Nut/Lock Washer/Washers. **Fig. 4**

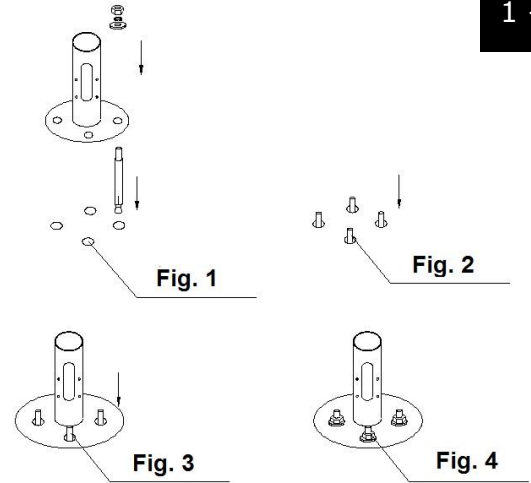

**Hardware Used:** 4 - M8x110 Expandable Bolts, 4 - M8 Nut/Lock Washer/Washer

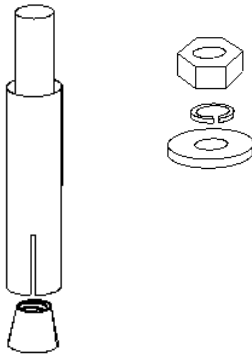

## **OPTION B (for soft ground such as soil):**

Set the Base in the desired location. Insert Anchoring Pin through hole in Base and using a rubber mallet, tap the Anchoring Pin into the soil. **Fig. 1**

Repeat with the other 3 - Anchoring Pins to secure the Base to the soil. **Fig. 2**

**Hardware Used:** 4 - Anchoring Pins

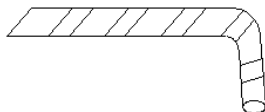
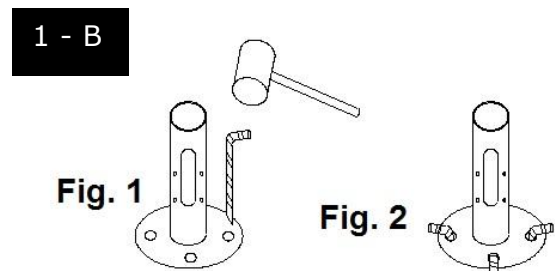

## ASSEMBLY

2. Once you have affixed the Base by one of the options above, slide the Lower Post (F) down over the Base (G). Align the holes in the Lower Post with the holes in the Base and insert 6 - M6x12 Bolts through Lock Washers and into the holes and hand tighten.

**Hardware Used:** 6 - M6x12 Bolt with Lock Washer

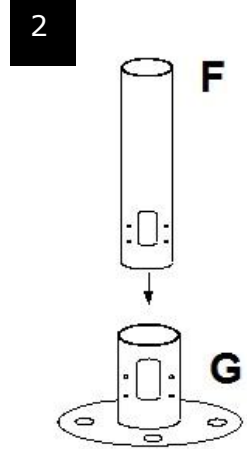

3. Slide the Base Cover (H) over the Lower Post (F) and Base (G).



4. Screw the two pieces of the Main Post (D) together. Then screw the Main Post (D) onto the Lower Post (F).

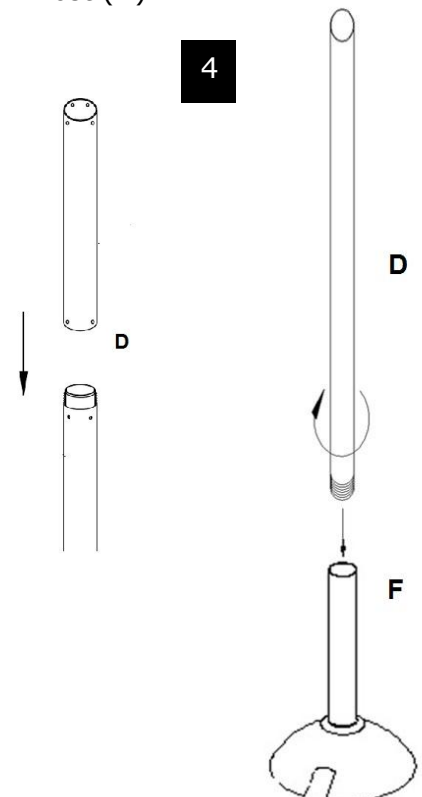



## ASSEMBLY

**6.** Attach Head Assembly (C) to Main Post (D).

**Note: There is a small piece of protective foam located in the neck of the Head Assembly that MUST be removed prior to attaching Head Assembly to the Upper Post.**

Route Gas Hose (E) down into Main/Lower post assembly and align 4 small holes on Head Assembly with 4 Small holes in Main Post (F).

[HINT: Control knob should be above decal on post.]

Insert 4 M6x10 (FF) bolts through 4 M6 lock washers into holes and tighten.

**Hardware Used:** 4 - M6x12 Bolt with Lock Washer

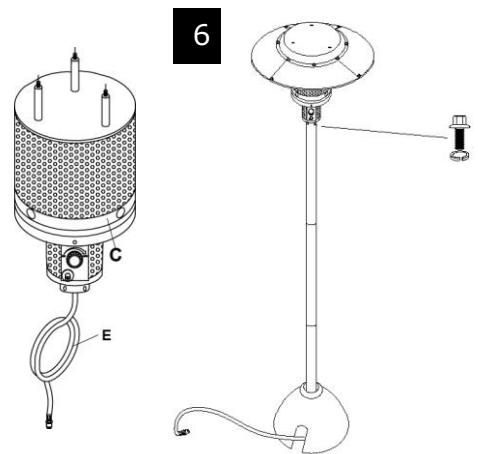
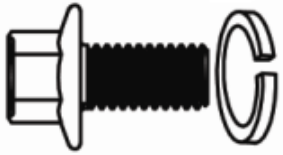

**7.** Assemble Reflector Panels (A) with Reflector Center Cap (B). Reflector Panels (A) come packaged in two brown boxes with two panels in each box. Hardware for assembly is already affixed to each panel. Place two panels side by side and remove the two cap nuts and washers that are affixed to one panel. Insert the affixed bolts into the open holes on the adjacent panel. Place the washer over the bolt and screw on cap nut. Repeat these steps until all four panels are assembled. Then locate the Reflector Center Cap (B). You will need to remove the cap nuts and washers located at the top of each Reflector Panel to allow assembly of the Center Cap on each panel. Align the holes in the Center Cap with the bolts on each panel and affix washer and cap nut to complete assembly.

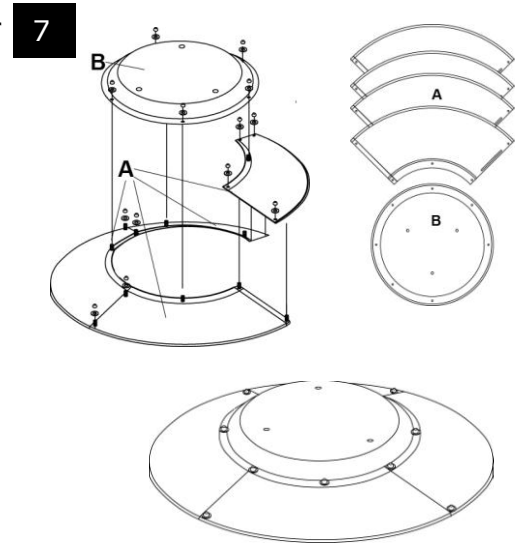

## ASSEMBLY

**8.** While supporting heater, tilt the Head Assembly (C) and slide the assembled Reflector over the 3 bolts that extend from the Head Assembly. Use 3 M8 Wing Nuts and 3 M8 Washers to secure the assembled Reflector to the Head Assembly of the heater. Once you have tightened the Wing Nuts, return the heater to an upright position.

**Hardware Used:** 3 - M8 Wing Nuts  
3 - M8 Washers

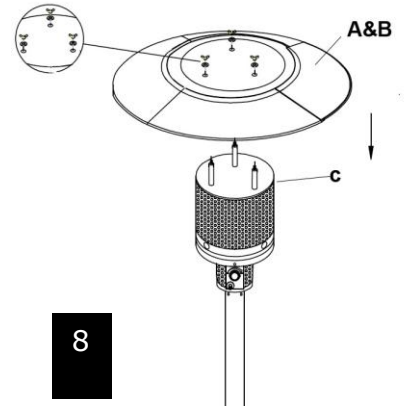
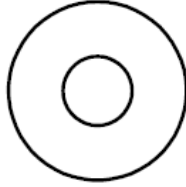

**9.** Connect the hose and regulator (from natural gas company) to the natural gas outlet. The natural gas is obtained from your natural gas supply company. Use a standard 7" WC natural gas only.

**NOTE:** Use this heater only with natural gas supply system. See chapter 5 of the standard for storage and handling of liquefied petroleum gas, ANSI/NFPA 58. Your local library or fire department should have this book.

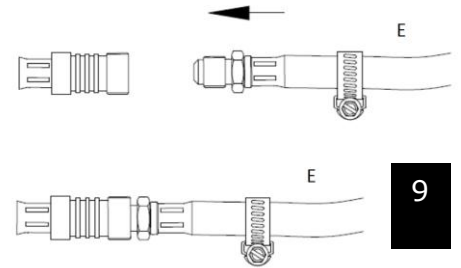

## ASSEMBLY

A minimum supply pressure of 7" W.C. is required for the purpose of input adjustment of natural gas. Storage of an appliance indoors is permissible only if the source is disconnected and removed from the appliance. A gas source must be stored outdoors in a well-ventilated area out of the reach of children. A disconnected gas source must have dust caps tightly installed and must not be stored in a building, garage, or any other enclosed area. The minimum permissible gas supply pressure of 7" W.C. is required for purpose of hose adjustment. The minimum hourly of 15,000 BTU is required input rating for a heater for automatic operation rating less than full input rating.

The pressure regulator and hose assembly used with the appliance must be in accordance with your gas source supplier.

Natural gas source may be hazardous and should be checked by your gas supplier. Never use natural gas source with a damaged valve connection.

The natural gas source must be constructed and marked in accordance with the specifications for gas source supplier of the U.S. Department of Transportation (DOT) or the standard for cylinders, spheres and tubes for transportation of dangerous goods and commission, CAN/CSA-B339.

- Do not store a natural gas source under or near this appliance.
- Place the dust cap on the gas source valve outlet whenever the source is not in use. Only install the type of dust cap on the natural gas valve. Other types of caps or plugs may result in leakage of propane.

## OPERATING INSTRUCTIONS

### Leak Test

#### WARNING

- \* Perform all leak tests outdoors.
- \* Extinguish all open flames.
- \* NEVER leak test when smoking.
- \* Do not use heater until all connections have been leak tested and show no signs of leakage.

1. Make 2-3 oz. of leak test solution (one part liquid dishwashing detergent and three parts water).
2. Apply several drops of solution where hose attaches to natural gas source regulator.
3. Apply several drops of solution where regulator connects to natural gas source pipe.
4. Make sure all patio heater valves are OFF.
5. Turn cylinder valve ON.

### **IF BUBBLES APPEAR AT ANY CONNECTION, THERE IS A LEAK.**

1. Turn natural gas valve OFF.
2. If leak is detected at hose/regulator connection, tighten connection and perform another leak test. If bubbles continue to appear, call our customer service hotline at **1-866-985-7877**, 9 a.m. – 6 p.m., EST, Monday – Friday.

## OPERATING INSTRUCTIONS

3. If leak is detected at regulator/gas source valve connection, disconnect, reconnect, and perform another leak test. If you continue to see bubbles after several attempts, cylinder valve is defective. Call our customer service hotline at **1-866-985-7877**, 9 a.m. – 6 p.m., EST, Monday – Friday

**IF NO BUBBLES APPEAR AT ANY CONNECTION, THE CONNECTIONS ARE SECURE.**

**Note: Whenever gas connections are loosened or removed, you must perform a complete leak test.**

	<b>WARNING:</b> FOR OUTDOOR USE ONLY
	<b>CARBON MONOXIDE HAZARD</b> This appliance can produce carbon monoxide which has no odor. Using it in an enclosed space can kill you. Never use this appliance in an enclosed space such as a camper, tent or home.

**Caution:** Do not attempt to operate this appliance until you have read and understand all Safety Information in this manual and all assembly is complete and leak tests have been performed.

### **Before Turning Gas Supply ON:**

1. Your heater was designed and approved for OUTDOOR use only. Do NOT use it inside a building, garage, or any other enclosed area.
2. Make sure surrounding areas are free of combustible materials, gasoline, and other flammable vapors or liquids.
3. Ensure that there is no obstruction to air ventilation. Be sure all gas connections are tight and there are no leaks.
4. Be sure the natural gas cover is clear of debris. Be sure any component removed during assembly or servicing is replaced and fastened prior to starting.

### **Before Lighting:**

1. Heater should be thoroughly inspected before each use, and by a qualified service person at least annually. If re-lighting a hot heater, always wait at least 5 minutes.
2. Inspect the hose assembly for evidence of excessive abrasion, cuts, or wear. Suspected areas should be leak tested. If the hose leaks, it must be replaced prior to operation. Only use the replacement hose assembly specified by the manufacturer.

### **Lighting:**

**NOTE:** For initial start or after any natural gas source, hold the control knob in for 2 minutes to purge air from all gas lines before proceeding.

1. Turn the control knob to the "OFF" position.
2. Fully open the gas source valve.
3. Turn the control knob half way between the small flame and the large flame symbols.
4. Push control knob in and then push the RED igniter button to ignite the main burner. Repeat until the burner ignites. Keep the control knob fully pushed in for an additional 30 seconds after the burner ignites, then release the control knob.
5. To increase the flame, turn the control knob clockwise toward the large flame symbol. To decrease the flame, turn the control knob counter clockwise towards the small flame symbol.
6. To turn the appliance OFF, push down the control knob and turn clockwise to the OFF position.
7. Wait at least 5 minutes before attempting to re-light the heater.
8. Turn the natural gas source valve to OFF or closed.

If you experience any ignition problems, please consult "Troubleshooting" on page 15.

**Caution:** Avoid inhaling fumes emitted from the heater's first use. Smoke and odor from the burning of oils used in the manufacturing will appear. Both smoke and odor will dissipate after approximately 30 minutes. The heater should NOT produce thick black smoke.

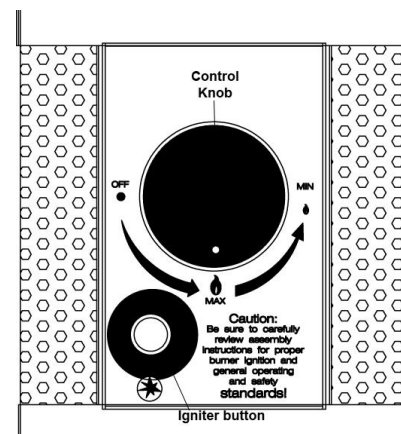

## ! WARNING

### FOR YOUR SAFETY

Be careful when attempting to manually ignite this heater. Holding in the control knob for more than 10 seconds before igniting the gas will cause a ball of flame upon ignition.

### **When Heater is ON:**

Emitter screen will become bright red due to intense heat. The color is more visible at night. Burner will display tongues of blue and yellow flame. These flames should not be yellow or produce thick black smoke, indicating an obstruction of airflow through the burners. The flame should be blue with straight yellow tops. If excessive yellow flame is detected, turn off heater and consult "Troubleshooting" on page 15.

### **Re-Lighting:**

**Note:** For your safety, control knob cannot be turned OFF without first depressing the control knob and then rotating to OFF.

1. Turn control knob to OFF.
2. Wait at least 5 minutes to allow gas to dissipate before re-lighting.
3. Repeat the "Lighting" steps listed on page 12.

## ! WARNING

### FOR YOUR SAFETY

Heater will be hot after use. Handle with extreme care.

### **Shut Down:**

1. Turn control knob clockwise to OFF while depressing the knob. (Normally, burner will make a slight popping noise when extinguished).
2. Turn natural gas source valve clockwise to OFF and disconnect regulator when heater is not in use.

**NOTE:** After use, some discoloration of the emitter screen is normal.

### **Operation Checklist:**

For a safe and pleasurable heating experience, perform this check before each use:

#### **Before Operating:**

1. I am familiar with entire owner's manual and understand all precautions noted.
2. All components are properly assembled, intact and operable.
3. No alterations have been made.
4. All gas connections are secure and do not leak.
5. Wind velocity is below 10 mph.
6. Unit will operate at reduced efficiency below 40 degrees F.
7. Heater is for use outdoors (outside any enclosure).
8. There is adequate fresh air ventilation.
9. Heater is away from gasoline or other flammable liquids or vapors.
10. Heater is away from windows, air intake openings, sprinklers and other water sources.
11. Heater is at least 36 in. on top and at least 24 in. on sides from combustible materials.
12. Heater is on a hard and level surface.
13. There are no signs of spider or insect nests in heater orifices.
14. All burner passages are clear.
15. All air circulation passages are clear.
16. Children and adults should be alerted to the hazards of high surface temperatures and should stay away to avoid burns or clothing ignition.
17. Young children should be carefully supervised when they are in the area of the heater.
18. Clothing or other protective material should not be hung from the heater, or placed on or near the heater.
19. Any guard or other protective device removed for servicing the heater must be replaced prior to operating the heater.
20. Installation and repair should be done by a qualified service person. The heater should be inspected before each use and at least annually by a qualified service person.
21. More frequent cleaning may be required as necessary. It is imperative that control compartment burner and circulating air passageways of the heater be kept clean and free of debris and/or spider or insect nests.

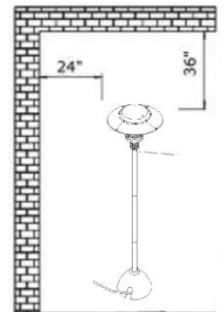

## After Operation:

1. Gas control knob is in OFF position.
2. Gas valve is OFF.
3. Disconnect gas line.

## CARE AND MAINTENANCE

### WARNING

#### FOR YOUR SAFETY

- \* Do NOT touch or move heater for at least 45 minutes after use.
- \* Reflector is hot to the touch.
- \* Allow reflector to cool before touching.

To enjoy years of outstanding performance from your heater, make sure you perform the following maintenance activities on a regular basis:

### Keep exterior surfaces clean.

1. Use soapy water for cleaning. Never use flammable or corrosive cleaning agents.
2. While cleaning your unit, be sure to keep the area around the burner and control compartment dry at all times. Do not submerge the control valve assembly. If the gas control is submerged in water, do NOT use it. It must be replaced.
3. Air flow must be unobstructed. Keep controls, burner, and circulating air passageways clean. Signs of possible blockage include:
  - Gas odor with extreme yellow tipping of flame.
  - Heater does NOT reach the desired temperature.
  - Heater glow is excessively uneven.
  - Heater makes popping noise.
  - Spiders and insects can nest in burner or orifices. This dangerous condition can damage heater and render it unsafe for use. Clean burner holes by using a heavy-duty pipe cleaner. Compressed air may help clear away smaller particles.
  - Carbon deposits may create a fire hazard. Clean dome and burner screen with warm soapy water if any carbon deposits develop.

Note: *In a salt-air environment (such as near an ocean), corrosion occurs more quickly than normal. Frequently check for corroded areas and repair them promptly.*

### TIP (FOR STAINLESS STEEL MODELS):

**Use high-quality automobile wax to help maintain the appearance of your heater. Apply to exterior surfaces from the post down. DO NOT apply to emitter screen or domes.**

### Storage:

Between uses:

- Turn control knob OFF.
- Disconnect LP source.
- Store heater upright in an area sheltered from direct contact with inclement weather (such as rain, sleet, hail, snow, dust and debris).
- If desired, cover heater to protect exterior surfaces and to help prevent build-up in air passages. Never leave LP cylinder exposed to direct sunlight or excessive heat.

**Note:** *Wait until heater is cool before covering.*

### Service:

Only a qualified service person should repair gas passages and associated components.

**Caution:** *Always allow heater to cool before attempting service.*

## TROUBLESHOOTING

If you have any questions regarding this product, please call our customer service hotline at 1-866-985-7877, 9a.m. – 6 p.m. (EST), Monday – Friday, or email us at [cservice@welltraveled.net](mailto:cservice@welltraveled.net).

PROBLEM	POSSIBLE CAUSE	CORRECTIVE ACTION
Main burner will not light	Gas valve may be off	Turn gas valve ON
	Fuel tank may be empty	Refill LPG tank
	Orifice blocked	Clean or replace orifice
	Air in supply system	Purge air from lines. Open gas lines and depress control knob for 2-3 mins.
	Loose connection	Check all fittings
	Igniter fails	Use stick lighter to manually light
	Gas pressure low with valve open full	Replace gas source supplier regulator
	New cylinder or 1st ignition	Purge air from lines
	Natural gas source valve on, no gas flow	Replace hose/regulator assembly
Low burner flame	Pressure is low	Replace gas source supplier regulator
	Gas hose is kinked	Check & straighten or replace
	Control knob at max	Check for obstruction at passageways and orifices
Burner unit	Carbon on reflector & emitter screen	Clean components as needed
	Thick black smoke	Blockage in burner assembly--thoroughly clean burner

## REPLACEMENT PARTS LIST

For questions regarding this product or to purchase replacement parts, please call our customer service hotline at 1-866-985-7877, 9a.m. – 6 p.m. (EST), Monday – Friday, or email us at [cservice@welltraveled.net](mailto:cservice@welltraveled.net).

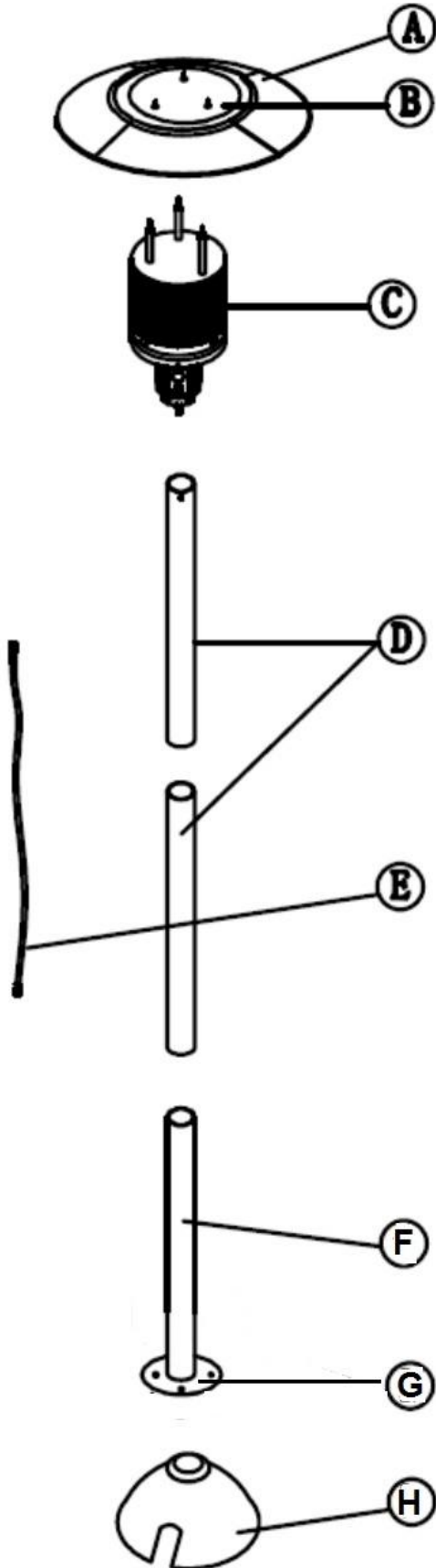

PART	DESCRIPTION	QTY
A	Reflector Panel	4 pcs (packed in 2 inner ctns)
B	Reflector Center Cap	1
C	Head Assembly	1 (packed in 1 inner ctn)
D	Main Post	2
E	Gas Hose	1 (attached to Head Assembly)
F	Lower Post	1
G	Base	1
H	Base Cover	1



**Distributed By:**  
Well Traveled Living  
716 S 8<sup>th</sup> Street  
Amelia Island, FL 32034  
Toll Free: 866-WTL-SUPP  
(866-985-7877)



Web: [www.wtliving.com](http://www.wtliving.com)  
Email: [cservice@welltraveled.net](mailto:cservice@welltraveled.net)

### **1 YEAR LIMITED WARRANTY – Customers in the Continental US**

All components are warranted for a period of 1 year after date of purchase by the original owner against defects in materials and workmanship under normal use. This warranty does NOT cover normal wear and weathering, assembly and/or maintenance OR use in a commercial application if model is not designated as a commercial model. At Well Traveled Living's sole discretion, products under warranty will be repaired and/or replaced at no charge to the customer. Any returns sent back to Well Traveled Living must be sent via prepaid freight and in the original retail packaging.

For warranty service contact Well Traveled Living at the address, phone numbers or internet site and email listed in this owner's manual. Be sure to have your sales receipt, date of purchase and catalogue/model numbers available when calling. All warranty service will be coordinated by the Well Traveled Living's, Amelia Island, Florida service center.

This warranty is extended only to the original purchaser. Proof of purchase will be required before warranty service is rendered. The sales receipt is the only valid proof of purchase. This warranty only covers failures due to defects in materials or workmanship which occur during normal use. Failures and/or damage which result from accident, negligence, misuse, abuse, neglect, mishandling, alteration or modification, failure to maintain, improper assembly or maintenance, service by unauthorized agency or use of unauthorized components or damage that is attributable to acts of God are NOT covered.

**\*\*\*THERE ARE NO EXPRESS WARRANTIES EXCEPT AS LISTED ABOVE\*\*\***

**\*\*\*PURCHASER ASSUMES ALL RISKS IN THE ASSEMBLY AND OPERATION OF THIS UNIT\*\*\***

**\*\*\*FAILURE TO FOLLOW WARNINGS AND OPERATIONAL INSTRUCTIONS CONTAINED IN THIS MANUAL CAN RESULT IN SEVERE PROPERTY DAMAGE AND/OR PERSONAL INJURY\*\*\***

**IN NO EVENT WILL WELL TRAVELED LIVING, OR ITS DIRECTORS, OFFICERS OR AGENTS BE LIABLE TO THE PURCHASER OR ANY THIRD PARTY, WHETHER IN CONTRACT, IN TORT, OR ON ANY OTHER BASIS, FOR ANY INDIRECT, SPECIAL, PUNITIVE, EXEMPLARY, CONSEQUENTIAL, OR INCIDENTAL LOSS, COST, OR DAMAGE ARISING OUT OF OR IN CONNECTION WITH THE SALE, MAINTENANCE, USE, OR INABILITY TO USE THE PRODUCT, EVEN IF WELL TRAVELED LIVING OR ITS DIRECTORS, OFFICERS OR AGENTS HAVE BEEN ADVISED OF THE POSSIBILITY OF SUCH LOSSES, COSTS OR DAMAGES, OR IF SUCH LOSSES, COSTS, OR DAMAGES ARE FORESEEABLE. IN NO EVENT WILL WELL TRAVELED LIVING, OR ITS OFFICERS, DIRECTORS, OR AGENTS BE LIABLE FOR ANY DIRECT LOSSES, COSTS OR DAMAGES THAT EXCEED THE PURCHASE PRICE OF THE PRODUCT.**

**SOME JURISDICTIONS DO NOT ALLOW THE EXCLUSION OR LIMITATION OF INCIDENTAL OR CONSEQUENTIAL DAMAGES, SO THE ABOVE LIMITATION OR EXCLUSION MAY NOT APPLY TO THE PURCHASER.**

This limited warranty gives you specific legal rights and you may also have other rights which vary from jurisdiction to jurisdiction. The provisions of the United Nations Convention on Contracts for the Sales of Goods shall not apply to this limited warranty or the sale of products covered by this limited warranty.

**\*\*\*IMPORTANT NOTICE\*\*\***

-Do **NOT** return to place of purchase-  
For customer service and warranty issues  
contact our Customer Service Center at:  
(866)-985-7877 OR  
Email: [cservice@welltraveled.net](mailto:cservice@welltraveled.net)  
Customer Service Hours: Mon. – Fri. 9:00 a.m. – 6:00 p.m.  
(EST)

Fire Sense®, Mojave Sun®, and Well Traveled Living® are registered trademarks of Well Traveled Imports, Inc®. All assembly instruction presentations are the property of Well Traveled Imports, Inc.® and are protected by U.S. copyrights and trademarks. All rights reserved.